

# LOAD BREAK SWITCH

IS 535737 - A  
Instruction sheet

HANDLE S00 - S0

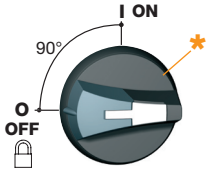

FSH00BR  
FSH00BR4

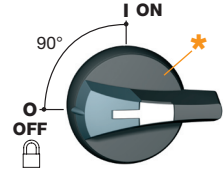
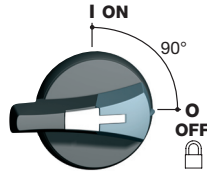
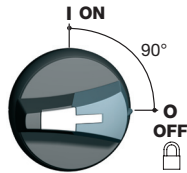

FSH0BR  
FSH0BR4

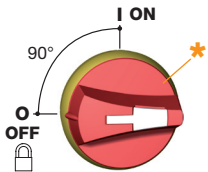

FSH00RR  
FSH00RR4

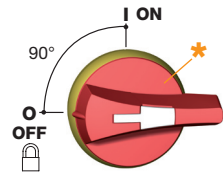
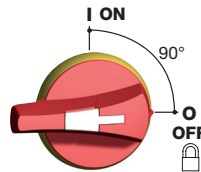
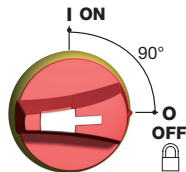

FSH0RR  
FSH0RR4

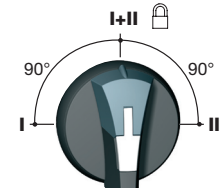
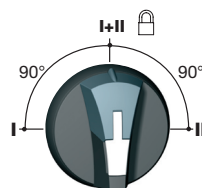
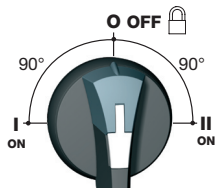
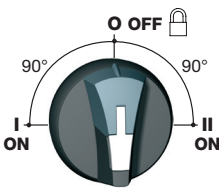

## TO REMOVE DEMONTAGE

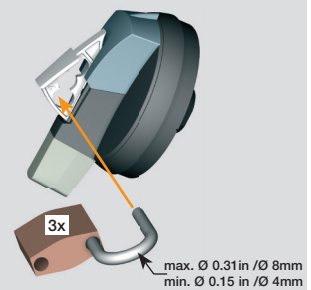
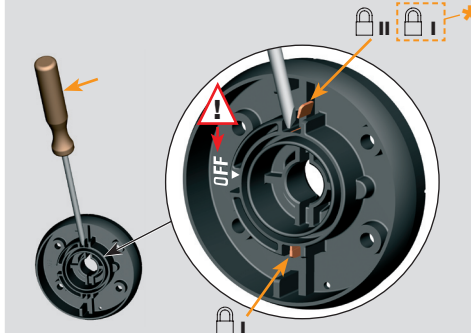
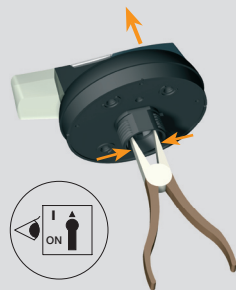

## ⚠ DANGER / PELIGRO

**HAZARDOUS VOLTAGE** . This equipment must be installed and serviced only by qualified electrical personnel. Turn off all power supplying this equipment before working on or inside equipment. Always use a properly rated voltage sensing device to confirm power is off. Replace all devices, doors, and covers before turning on power to this equipment. **Failure to follow these instructions will result in death or serious injury.**

**TENSION DANGEREUSE.** L'installation et l'entretien de cet appareil ne doivent être effectués que par du personnel qualifié. Coupez l'alimentation de cet appareil avant d'y travailler. Utilisez toujours un dispositif de détection de tension à valeur nominale approprié pour confirmer que toute alimentation est coupée. Remplacez tous les dispositifs, les portes et les couvercles avant de mettre cet appareil sous tension. **Si ces précautions ne sont pas respectées, cela entraînera la mort ou des blessures graves.**

**TENSION PELIGROSA.** Solamente el personal de mantenimiento eléctrico especializado deberá instalar y prestar servicios de mantenimiento a este equipo. Desenergice el equipo antes de realizar cualquier trabajo en él. Siempre utilice un dispositivo detector de tensión adecuado para confirmar la desenergización del equipo. Vuelva a colocar todos los dispositivos, las puertas y las cubiertas antes de energizar este equipo. **El incumplimiento de estas precauciones podrá causar la muerte o lesiones serias.**

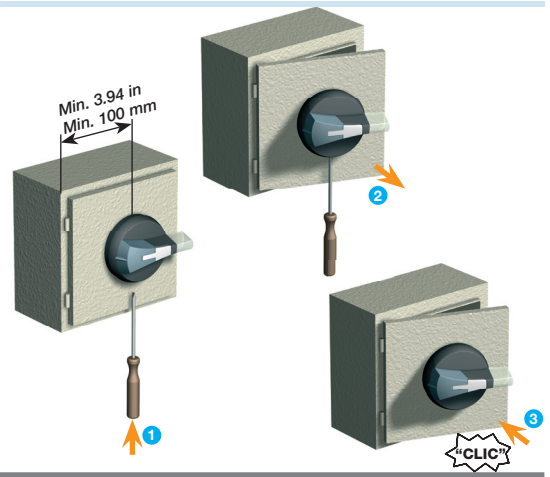
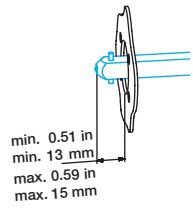
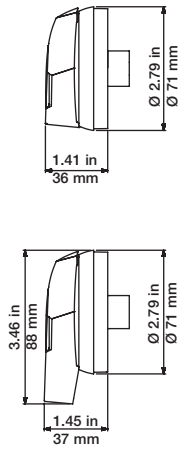
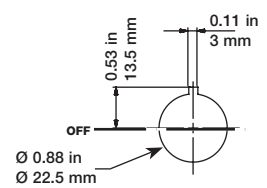
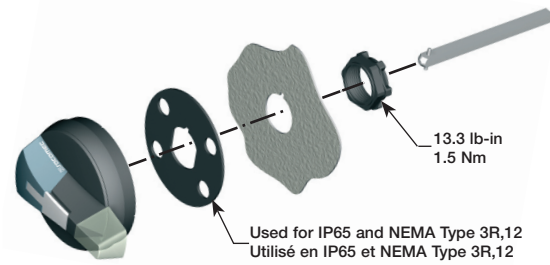
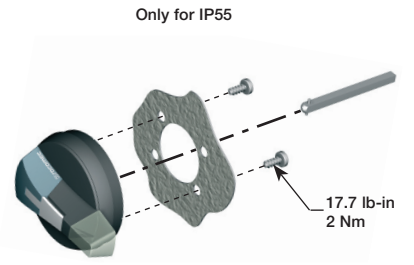
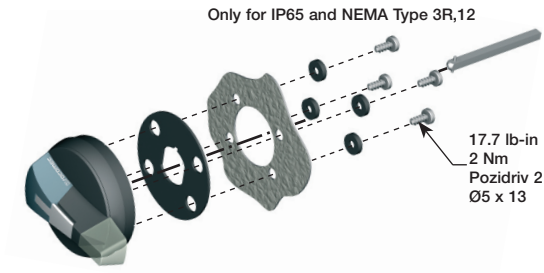
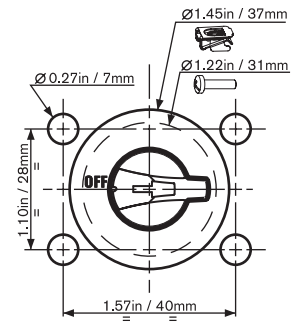
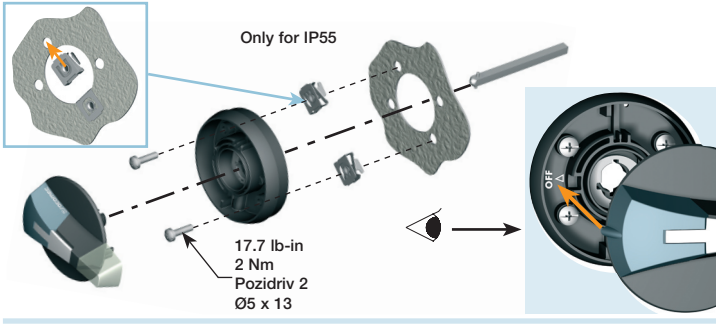

**⚠ DANGER / PELIGRO**

**HAZARDOUS VOLTAGE** . Disconnect all power before servicing. Be sure enclosure is closed securely before operating device.  
Testing of live equipment should only be performed by qualified service personnel in accordance with local regulations. **Failure to follow these instructions will result in death or serious injury.**

**TENSION DANGEREUSE.** Couper l'alimentation avant intervention. S'assurer de la fermeture du coffret avant manoeuvre de l'appareil.  
Les essais des équipements sous tensions ne doivent être effectués que par du personnel qualifié. **Si ces précautions ne sont pas respectées, cela entrainera la mort ou des blessures graves.**

**TENSION PELIGROSA.** Desenergice el equipo antes de una itervención. Asegurarse del cierre de la caja antes de manipular el equipo.  
Solamente el personal especializado debiera probar los equipos sobre tension. **El incumplimiento de estas precauciones podrá causar la muerte o lesiones serias.**