

REV.	DATE	ECO	DESCRIPTION	BY	CK	APP
-	8/30/2013	N/A	INITIAL RELEASE	GDR	N/A	N/A

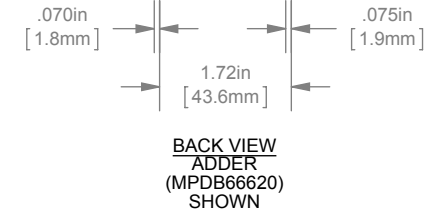

DIMENSIONS IN [ ] ARE MILLIMETERS

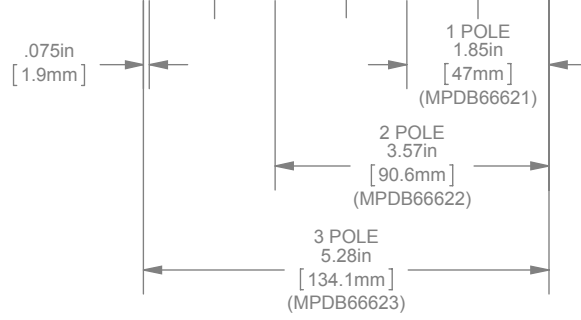
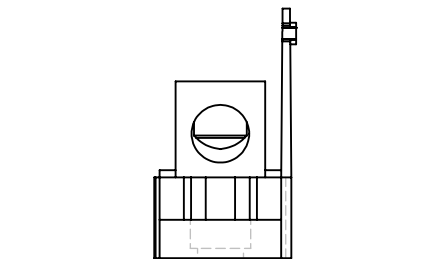
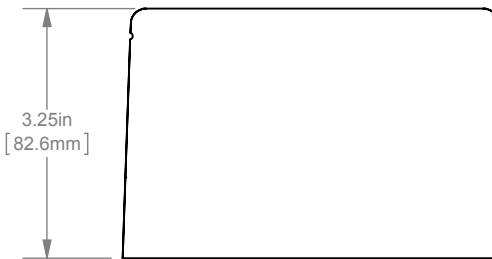
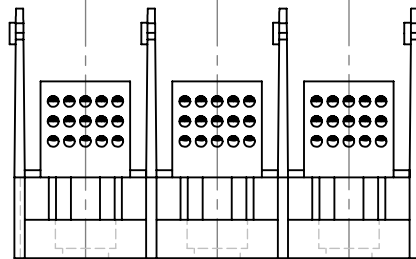
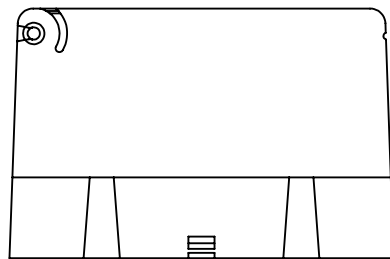
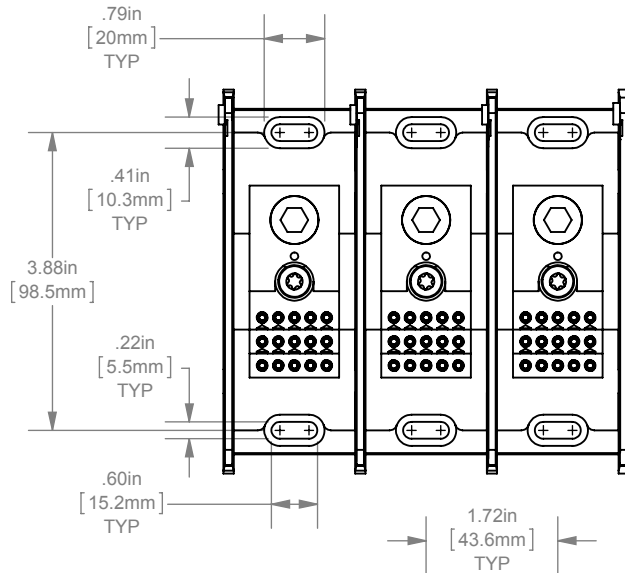

MERSEN USA NEWBURYPORT-MA, LLC  
374 MERRIMAC STREET  
NEWBURYPORT, MA 01950

**MPDB(66620,66621,66622,66623)**  
**PDB 1-3, ADDER COPPER INTERMEDIATE**  
**(1)350-6 X (15)10-14**

OUTLINE DIMENSIONS  
NOT TO BE USED FOR PRODUCTION

**701989**

**PRODUCT MANAGER**  
SIGN:  
DATE:

**DESIGN ENGINEER**  
SIGN:  
DATE: (SEE ECO)