



**Your problem:** You need a range of disconnect switches for your industrial control requirements ranging from “Service Entrance Rated” to motor isolation. You need DIN-rail and direct mountable disconnect switches that conform to “finger-safe” standards. You need a flexible range of handles, shafts, and accessories to select from.

**Our solution:** Mersen offers an extensive line of compact UL 98 fusible and non-fusible disconnect switches ranging from 30 to 1200A. We also offer a full range of compact UL 508 disconnect switches ranging from 16 to 80A. In addition, you can find handle, shaft and accessory options that you require for all of your applications.

**Want more information fast?** For more technical or application-specific information, please call our Disconnect Switch experts at 978-248-8914 or visit our website at [mersen.com](http://mersen.com).

# Low Voltage Switches

**THE SAFEST WAY  
TO SWITCH POWER ON AND  
OFF IN YOUR INDUSTRIAL  
CONTROL PANELS**

- UL 508 Non-Fusible Disconnect Switches. . . . . DS 2
- UL 98 Non-Fusible Disconnect Switches. . . . . DS 6
- UL 98 Fusible Disconnect Switches. . . . . DS 11
- PV-Rated UL and IEC Disconnect Switches. . . . . DS 16
- Enclosed Disconnect Switches. . . . . DS 19
- Compact Fused Switch Class CC . . . . . DS 25

# UL 508 Non-Fusible

Disconnect Switches

LOW VOLTAGE SWITCHES

M163 – M803



The M-series Load Break Switch is the most compact industrial-grade switch on the market. Capable of making or breaking loads up to 600V (UL), it is suitable as a motor disconnect. Extremely compact and robust, these switches have a variety of mounting options including DIN-rail, base, or door-mounting. A wide assortment of handles, shafts and accessories is available to accommodate any installation requirement.

Catalog number designation			
<b>M</b> Switch   M = Mersen AC Switch	<b>80</b> Ampacity   16-80	<b>3</b> Number of Poles 	— Special Configurations   DM: Door Mounting

## RATINGS (UL):

- **Volts:** 600VAC
- **Amps:** 20, 30, 40, 63, and 80A. Suitable as motor disconnect up to 40hp.

## FEATURES/BENEFITS:

- Compact
- Robust
- DIN-rail, base, or door mounting
- Choice of handles and shafts
- Padlockable
- Side-mount auxiliary contacts and additional poles
- Double-break, silver-plated, contacts

## APPLICATIONS:

- Line-of-sight disconnect
- Electrical isolation
- Branch-circuit switch
- Motor disconnect

## APPROVALS:

- UL 508 listed E196672
- IEC 60947-3













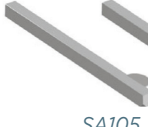

© 2024 Mersen. All rights reserved. Mersen reserves the right to change, update, or correct, without notice, any information contained in this datasheet.

# UL 508 Non-Fusible Disconnect Switches (M163 - M803)

LOW VOLTAGE  
SWITCHES

## UL 508 Disconnect Switches—Front Operated

UL 508 Disconnect Switches—Front Operated						
				M163	M163DM	M633
<b>Switch Body</b>	<b>Ampere Rating</b>	<b>20</b>	<b>30</b>	<b>40</b>	<b>63</b>	<b>80</b>
	Base Part #	M163	M253	M403	M633	M803
	Door-Mounted Version	M163DM	M253DM	M403DM		
<b>Handles and Shafts</b>	<b>Direct Front Operation Locking Handle</b>					
		HD40	HD40	HD40	HD125	HD125
	<b>External Front Operation</b>					
	Minimum recommended handle length	45 mm				
	Selector Style NEMA Type 1, 3R, 12	HSBX, HSRX				
	Shaft—SAxxx (xxx = length in mm)	SA85, SA105, SA120, SA130, SA180, SA250				
	Door mounted version (no shaft required)	HSBPDM, HSRPDM				
	Pistol Style NEMA Type 1, 3R, 12	HB45, HR45, HB65, HR65, HB80, HR80				
	NEMA Type 4, 4X	HB45X, HR45X, HB65X, HR65X, HB80, HB80X				
	NEMA 4X Stainless Steel	HM65X				
	Shaft—SAxxx (xxx = length in mm)	SPA130, SPA210, SPA290, SPA360, SPA430				
	B=Black, R=Black					
<b>Accessories</b>	<b>Fourth Poles</b>					
	Limited to one additional pole per switch	4P40	4P40	4P40	4P80	4P80
	Door mounted switch 4th poles are left-side mounted	4P40DM	4P40DM	4P40DM		
	<b>Neutral Poles</b>					
	Limited to one additional pole per switch	NP40	NP40	NP40	NP80	NP80
	Door mounted switch neutral poles	NP40DM	NP40DM	NP40DM		
	<b>Terminal Shrouds</b>					
	3-pole	TS40-3	TS40-3	TS40-3	TS63-3	TS63-3
	4-pole (Add this to the 3-pole shroud)	TS40-1	TS40-1	TS40-1	TS63-1	TS63-1
	<b>Auxiliary Contacts*</b>					
	NC Right side mounting	OA1G01	OA1G01	OA1G01	OA1G01	OA1G01
	NO left side mounting**	OA1G10	OA1G10	OA1G10	OA1G10	OA1G10
	NO+NC (Mounting on either side)***	OA2G11	OA2G11	OA2G11	OA2G11	OA2G11
	*Rated 2A max continuous @690VAC					
* Minimum switching capacity for the auxiliary contacts OA1G01, OA1G10, OA2G11 is 10mA at a voltage of 24V DC.						
** Auxiliary contact OA1G10 breaks prior to main contacts opening.						
*** Auxiliary contact OA2G11 simultaneously functions with main contacts.						

© 2024 Mersen. All rights reserved. Mersen reserves the right to change, update, or correct, without notice, any information contained in this datasheet.

TECHNICAL DATA ACCORDING TO UL/cULus															
Part Number				M163		M253		M403		M633		M803			
General Purpose Amp Rating	pf= 0.7...0.8	-40° to 40 °C	A	20		30		40		60		80			
Maximum Operating Voltage			V	600		600		600		600		600			
Max. horsepower rating / motor FLA current	pf= 0.4...0.5 Three phase	240 V	HP/A	5/15.2		7.5/22.0		10/28.0		15/42.0		20/54.0			
		480 V	HP/A	10/14.0		15/21.0		20/27.0		30/40.0		40/52.0			
		600 V	HP/A	10/11.0		20/22.0		25/27.0		30/32.0		40/41.0			
	Single phase	120 V	HP/A	1/16.0		1.5/20.0		2/24.0		2/24.0		2/24.0			
		240 V	HP/A	2/13.2		3/18.7		5/30.8		7.5/40.0		10/57.5			
Short circuit rating with fuse	Maximum fuse size		A	30		60 <sup>2)</sup>		30		60 <sup>2)</sup>		100		150	
	Fuse type	CC	kA	10		10		10		10		100		100	
	Fuse type	J	kA	10		10		10		10		100		100	
	Fuse type	T	kA	10		10		10		10		100		100	
	Fuse type	RK1	kA	10		10		10		10		5		10	
	Fuse type	RK5	kA	5		5		5		5		5		5	
	Fuse type	L	kA												
	Fuse type	H	kA												
<b>Endurances</b>															
Min. electrical endurance, pf. 0.75...0.8			oper. cycles	6 000		6 000		6 000		6 000		6 000			
Mechanical endurance			operations	20 000		20 000		20 000		20 000		20 000			
Terminal lug kits				Integral		Integral		Integral		Integral		Integral			
Wire range			AWG	18-8		18-8		18-8		14-4		14-4			
Torque		Wire tightening	lb. in	7		7		7		18		18			
		Lug mounting													

## TEMPERATURE DERATING

Amb. °C (Min)	Amb. °C (Max)	Thermal current (Ith) derating
35	40	1.00
40	45	0.96
45	50	0.93
50	55	0.89
55	60	0.85

Amb. °C (Min)	Amb. °C (Max)	Thermal current (Ith) derating
60	65	0.80
65	70	0.76
70	75	0.71
75	80	0.65
80	85	0.60

# UL 508 Non-Fusible Disconnect Switches (M163 - M803)

LOW VOLTAGE  
SWITCHES

TECHNICAL DATA ACCORDING TO IEC 60947-3								
Part Number				M163	M253	M403	M633	M803
General Purpose Amp Rating	pf= 0.7...0.8	-40° to 40 °C	A	20	30	40	60	80
Rated insulation voltage and rated operational voltage AC20/DC20	Pollution degree 3	50 Hz 1 min.	V	750	750	750	750	750
Dielectric strength			kV	6	6	6	6	6
Rated impulse withstand voltage			kV	8	8	8	8	8
Rated thermal current and rated operational current AC20/DC20 ...with minimum conductor cross section	Ambient 40 °C <sup>2)</sup>	In open air		25 A	32 A	40 A	63 A	80 A
	Ambient 40 °C <sup>2)</sup>	In enclosure		25 A	32 A	40 A	63 A	80 A
	Ambient 60 °C	In enclosure		20 A	25 A	32 A	50 A	63 A
Rated operational current, AC-21A	Cu			4 mm <sup>2</sup>	6 mm <sup>2</sup>	10 mm <sup>2</sup>	16 mm <sup>2</sup>	25 mm <sup>2</sup>
	up to 415 V	A		16	25	40	63	80
Rated operational current, AC-22A	440...690 V	A		16	25	40	63	80
	up to 415 V	A		16	25	40	63	80
Rated operational current, AC-23A	440...690 V	A		16	25	40	63	80
	up to 415 V	A		16	20	23	63	75
	440 V	A		16	20	23	63	65
	500 V	A		16	20	23	45	58
Rated operational current / poles in series, DC-21A	690 V	A		10	11	12	20	20
	24...48 V <sup>1)</sup>			16 A/1	25 A/1	32 A/1	63 A/1	80 A/1
	110 V			16 A/2	25 A/2	32 A/2	63 A/2	80 A/2
	220 V			16 A/3	25 A/3	32 A/3	63 A/3	80 A/3
	440 V			16 A/4	16 A/4	16 A/4	16 A/4	16 A/4
	500 V			16 A/4	16 A/4	16 A/4	16 A/4	16 A/4
	750 V			16 A/8	25 A/8	32 A/8	-	-
Rated operational current / poles in series, DC-22A	24...48 V <sup>1)</sup>			16 A/1	25 A/1	32 A/1	63 A/1	80 A/1
	110 V			16 A/2	25 A/2	32 A/2	63 A/2	80 A/2
	220 V			16 A/3	25 A/3	32 A/4	45 A/4	45 A/4
	440 V			10 A/4	10 A/4	10 A/4	10 A/4	10 A/4
Rated operational current / poles in series, DC-23A	750 V			16 A/8	25 A/8	25 A/8	-	-
	24...48 V <sup>1)</sup>			16 A/1	25 A/1	32 A/1	63 A/1	80 A/1
	110 V			16 A/2	25 A/2	32 A/2	63 A/2	80 A/2
	220 V			16 A/3	25 A/3	32 A/4	45 A/4	45 A/4
Rated operational power, AC-23A (These values are given for guidance and may vary acc. to the motor manufacturer)	440 V			10 A/4	10 A/4	10 A/4	10 A/4	10 A/4
	750 V			16 A/8	16 A/8	16 A/8	-	-
	220...240 V			3 kW	4 kW	5.5 kW	11 kW	22 kW
	400...415 V			7.5 kW	9 kW	11 kW	22 kW	37 kW
Rated breaking capacity, AC-23A	440...500 V			7.5 kW	9 kW	11 kW	22 kW	37 kW
	690 V			7.5 kW	9 kW	11 kW	15 kW	18.5 kW
	up to 415 V			128 A	160 A	184 A	360 A	640 A
	440 V			128 A	160 A	184 A	360 A	448 A
Rated breaking capacity/ poles in series, DC-23A	500 V			128 A	160 A	184 A	360 A	464 A
	690 V			80 A	88 A	96 A	160 A	160 A
	24...48 V			64 A/1	100 A/1	128 A/1	180 A/1	252 A/1
	110 V			64 A/2	100 A/2	128 A/2	180 A/2	252 A/2
	220V			64 A/3	100 A/4	128 A/4	180 A/4	180 A/4
Rated conditional short-circuit current I <sub>c</sub> (r.m.s.) and corresponding max. Allowed cut-off current I <sub>c</sub> of fuse. The cut-off current I <sub>c</sub> refers to values listed by fuse manufacturers (single phase test acc. To IEC60269)	440 V			40 A/4	40 A/4	40 A/4	40 A/4	40 A/4
	750 V			64 A/8	64 A/8	64 A/8	-	-
	I <sub>c</sub> 50kA, ≤415V Max. OFA fuse size	I <sub>c</sub> gG/aM		6.5 ka 40 A/32 A	6.5 kA 40 A/32 A	6.5 kA 40 A/32 A	13 kA 100 A/80 A	13 kA 100 A/80 A
	I <sub>c</sub> 100kA, 500V Max. OFA fuse size	I <sub>c</sub> gG/aM		-	-	-	17 kA 100 A/80 A	17 kA 100 A/80 A
	I <sub>c</sub> 10kA, 690V Max. OFA fuse size	I <sub>c</sub> gG/aM		-	-	-	-	-
Rated short-time withstand current	I <sub>c</sub> 50kA, 690V Max. OFA fuse size	I <sub>c</sub> gG/aM		4 kA 25 A/16 A	4 kA 25 A/16 A	4 kA 25 A/16 A	11 kA 80 A/63 A	11 kA 80 A/63 A
	r.m.s. -value I <sub>cw</sub>	690 V, 1 s	kA	0.5	0.5	0.5	1	1.5
Rated short circuit making capacity	Peak value I <sub>cm</sub>	690 V/500 V	A	0.71	0.71	0.71	1.4	2.1
Rated capacitor power (the capacitor ratings are limited by the fuse link.)		400...415 V		6.5 kVAr	10 kVAr	15 kVAr	25 kVAr	30 kVAr
Power loss / pole	At rated operational current		W	0.3	0.6	1.6	2.8	4.5
Mechanical endurance	Divide by two for operation cycles		Oper.	20 000	20 000	20 000	20 000	20 000
Weight without accessories	3-pole		kg	0.11	0.11	0.11	0.27	0.27
	4-pole		kg	0.15	0.15	0.15	0.35	0.35
Cable size	Cu-wire size suitable for terminal clamps			0.75...10 mm <sup>2</sup> 18-8 AWG	0.75...10 mm <sup>2</sup> 18-8 AWG	0.75...10 mm <sup>2</sup> 18-8 AWG	1.5...35 mm <sup>2</sup> 14-4 AWG	1.5...35 mm <sup>2</sup> 14-4 AWG
Terminal tightening torque	Counter torque required			0.8 Nm	0.8 Nm	0.8 Nm	2 Nm	2 Nm
Operating torque	3-pole switch-disconnector			1 Nm	1 Nm	1 Nm	1.2 Nm	1.2 Nm

1) UL Listed switches are also CSA Approved. 2) Fuse size 70A for RK5.  
Below 48 V, two poles in parallel up to M803 are recommended particularly in polluted atmosphere.

© 2024 Mersen. All rights reserved. Mersen reserves the right to change, update, or correct, without notice, any information contained in this datasheet.

# UL 98 Non-Fusible

## Disconnect Switches

### LOW VOLTAGE SWITCHES



Mersen's non-fusible disconnect switches are listed to UL 98 and bear the CE mark as conformance to IEC 60947-3. They are "service entrance" devices that are capable of fully rated load-break and load-make. All switches over 100A have windows to provide visual indication of the contact status. Engineered to have the smallest footprint, these switches also employ a modular design that enables the handle to be placed amongst the poles or at the ends.

A wide range of ergonomic handles and accessories is available to accommodate multiple applications.

### CONFIGURATIONS:



Gearbox on the side

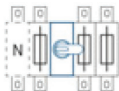

Gearbox in the middle

Catalog number designation						
<b>M</b> Switch	<b>200</b> Ampacity	<b>U</b> Type	<b>3</b> Number of Poles/Left of handle	<b>0</b> Number of Poles/Right of handle	— Revision	— Special Configuration
M = Mersen AC Switch	16-1200	U = non-fused UL 98	1-3	Blank = < 200A non-fused, 0, 2, 3	Blank = 0	DM = Door mounted

\*Not all configurations are available.

### RATINGS (UL):

- **Volts:** 600VAC
- **Amps:** 30A, 60A, 100A, 200A, 400A, 600A, 800A, 1200A
- **Short-Circuit Current Rating (SCCR):** Up to 200kA with fuses. Suitable as motor disconnect.



### FEATURES/BENEFITS:

- Service entrance rated
- Front operation
- Most compact size
- Internally mounted auxiliary contacts
- Flexible mounting
- Adjustable shaft depth

### APPROVALS:

- All UL switches meet the requirements of UL and CSA
- UL listed guide WHTY, File E191605 for UL 98 (ratings from 30 A to 1200 A)
- IEC 60947-3



UL 98 DISCONNECT SWITCHES					
 <p>M100U3</p>		 <p>M200U30 with HD250 Direct Handle</p>		 <p>M200U30</p>	
Switch Body	Ampere Rating	30	60	100	200
	Base Part #	M30U3	M60U3	M100U3	M200U
	3-pole configurations				12, 30
	For Door-mounting	M30U3DM	M60U3DM	M100U3DM	
Handles and Shafts	Direct Front Operation Locking Handle	HD125	HD125	HD125	HD250
	External Front Operation				
	Minimum recommended handle length	45 mm			
	Selector Style	HSBX, HSRX			N/A
	Shaft—SAxxx (xxx = length in mm)	SA85, SA105, SA120, SA130, SA180, SA250			N/A
	Door mounted version (no shaft required)	HSBWDM, HSRWDM			N/A
	Pistol Style NEMA Type 1, 3R, 12	HB45, HR45, HB65, HR65, HB80, HR80			
	NEMA Type 4, 4X	HB45X, HR45X, HB65X, HR65X, HB80X, HR80X			
	NEMA 4X Stainless Steel	HM65X			
	Shaft—SAxxx (xxx = length in mm)	SPA130, SPA210, SPA290, SPA360, SPA430			
	Alignment Ring	See next page			
	B=Black, R=Red				
Accessories	Fourth Poles	4P60	4P60	4P125	4P250
	Base-mounted switch Fourth Poles				
	Door-mounted switch Fourth Poles	4P60DM	4P60DM	4P125DM	
	Neutral Poles	NP60	NP60	NP125	
	Base-mounted switch Neutral Poles				
	Door-mounted switch Neutral Poles	NP125DM	NP125DM	NP125DM	
	Terminal Shrouds	TS125-3	TS125-3	TS125-3	TS250-13
	3-pole				
	4-pole	TS125-1	TS125-1	TS125-1	TS250-14
	Shrouds with "-3" suffix are single shrouds that cover all three terminals. Shrouds with "-13" or "-14" are single pole shrouds with 3 or 4 per				
	Auxiliary Contacts*	OA1G01	OA1G01	OA1G01	OA3G01
	Normally Closed				
	Normally Open	OA1G10	OA1G10	OA1G10	OA1G10
	NO+NC	OA2G11	OA2G11	OA2G11	
	Module for 8 aux. contacts	N/A	N/A	N/A	OEA28
	*Rated 2A max continuous @690VAC				
	Flange Operation	N/A	N/A	N/A	F0M4
	Flange bracket assembly				
	Rod Flange handle NEMA 12	N/A	N/A	N/A	N/A
	Rod Flange handle NEMA 4X	N/A	N/A	N/A	N/A
	Rod, 16 inch	N/A	N/A	N/A	N/A
	Rod, 24 inch	N/A	N/A	N/A	N/A
	Cable Flange Handle, NEMA 12	N/A	N/A	N/A	FHC12
	Cable Flange Handle, NEMA 4X	N/A	N/A	N/A	FHC4X
	Cable for FHC handles	N/A	N/A	N/A	CABLE36*

Other cable lengths available: 48", 60", 72", 84", 96", 108". For example, CABLE108. \*\*These switches have not been tested to conform to UL standards

© 2024 Mersen. All rights reserved. Mersen reserves the right to change, update, or correct, without notice, any information contained in this datasheet.



UL LISTED FRONT OPERATED



M400U30



M600U30



M200U30

Switch body	Ampere Rating	400	600	800	1200
Base Part #		M400U	M600U	M800U	M1200U
3-pole configurations		30, 12	30, 12	30, 12	30
Handles and Shafts	Direct Front Operation Locking Handle				
<p>SFB185</p> <p>HD800</p>		HD400	HD800	HD800	HD1000
	External Front Operation				
	Minimum recommended handle length	95 mm	125 mm	125 mm	274 mm
	Pistol Style NEMA Type 1, 3R, 12	HB125, HB145, HB274			
	NEMA Type 4, 4X	HB125X, HB145X, HB274X			
	NEMA 4X Stainless Steel	HM125X, HM175X			
	Shaft — Sxxxx (xxx = length in mm)	SFB185, SFB280, SFB325, SFB395, SFB535			
Alignment Ring (optional, for pistol-style handle)	ALRX10				
B=Black. Substitute 'R' for 'B' if a red handle is desired. Ex. HR125					
Accessories	Fourth Poles				
<p>4P400</p> <p>TS250-13</p> <p>OA1G10 OA3G01 OEA28</p>		4P400	4P800	4P800	4P1250
	Terminal Lugs				
	6 per package	LUG400 #2 - 600MCM	LUG800 2 x #2 600MCM	LUG800 2 x #2 600MCM	LUG1200 4 x #2 600MCM
	Terminal Shrouds				
	1-pole	TS400-13	TS800-13	TS1600-13	TS1600-13
3-pole	TS400-3	TS600-3	TS800-3	TS1200-3	
4-pole	TS400-14	TS800-14	TS1600-14	TS1600-14	
Shrouds with "-3" suffix are single shrouds that cover all three terminals. Shrouds with "-13" or "-14" are single pole shrouds with 3 or 4 per switch. Single pole shrouds are not compatible with the UL Lugs listed above.					
Auxiliary Contacts*					
Normally Open	OA1G10	OA1G10	OA1G10	OA1G10	
Normally Closed	OA3G01	OA3G01	OA3G01	OA3G01	
Module for 8 aux. contacts	OEA28	OEA28	OEA28	OEA28	
*Rated 2A max continuous @690VAC					

## TEMPERATURE DERATING

Amb. °C (Min)	Amb. °C (Max)	Thermal current (Ith) derating
35	40	1.00
40	45	0.96
45	50	0.93
50	55	0.89
55	60	0.85

Amb. °C (Min)	Amb. °C (Max)	Thermal current (Ith) derating
60	65	0.80
65	70	0.76
70	75	0.71
75	80	0.65
80	85	0.60

© 2024 Mersen. All rights reserved. Mersen reserves the right to change, update, or correct, without notice, any information contained in this datasheet.



TECHNICAL DATA ACCORDING TO UL/cULus								
Part Number				M30U3	M60U3	M100U3	M200Uxx	
General Purpose Amp Rating	pf= 0.7...0.8	-5° to 40 °C	A	30	60	100	200	
Maximum Operating Voltage			V	600	600	600	600	
Max. horsepower rating / motor FLA current	pf= 0.4...0.5 Three phase	240 V	HP/A	10/28.0	20/54.0	30/80.0	75/192.0	
		480 V	HP/A	20/27.0	40/52.0	50/65.0	150/180.0	
		600 V	HP/A	30/32.0	40/41.0	50/52.0	200/192.0	
	Single phase	120 V	HP/A	2/24.0	3/34.0	5/56.0		
240 V		HP/A	5/28.0	7.5/40.0	15/68.0			
Short circuit rating with fuse	Maximum fuse size		A	60	150	150	200	400
	Fuse type	CC	kA					
	Fuse type	J	kA	50	50	50	200	65
	Fuse type	T	kA	50	50	50		
	Fuse type	RK1	kA					
	Fuse type	RK5	kA					
	Fuse type	L	kA					
Fuse type	H	kA						
Maximum General Use, DC Ratings								
Current rating		at 250 VDC	A				200	
		at 600 VDC	A				100	
DC horsepower rating for 4-pole switch		at 600 VDC	HP				50	
DC horsepower rating for 2-pole switch	In open air	at 125 VDC	HP				20	
	In enclosure <sup>2)</sup>	at 250 VDC	HP				-	
DC short circuit rating for 4-pole switch	with circuit breaker		kA				10	
DC short circuit rating for 2-pole switch	with circuit breaker at 250 VDC		kA				14	
	with circuit breaker at 600 VDC		kA				10	
	with class J fuse at 250 VDC		kA				100	
	... with fuse size		A				200	
endurances								
Min. electrical endurance, pf. 0.75...0.8			oper. cycles	6 000	6 000	6 000	6 000	
Mechanical endurance			operations	20 000	20 000	20 000	20 000	
Terminal lug kits				Integral	Integral	Integral	LUG-200	
Wire range			AWG	14-4	14-4	8-1/0	4-300MCM	
Torque		Wire tightening	lb. in	55	55	55	275	
		Lug mounting					72	
TECHNICAL DATA ACCORDING TO IEC 60947-3								
Rated insulation voltage and rated operational voltage AC20/DC20	Pollution degree 3	V		750	750	750	1 000	
Dielectric strength	50 Hz 1min.	kV		6	6	6	10	
Rated impulse withstand voltage		kV		8	8	8	12	
Rated operational current, AC-22A	up to 415 V	A		40	63	100	250	
	440...500 V	A		40	63	100	250	
	690 V	A		40	63	100	250	
Rated operational current, AC-23A	up to 415 V	A		40	63	80	250	
	440 V	A		40	63	65	250	
	500 V	A		40	63	60	250	
	690 V	A		40	63	40	250	
Rated conditional short-circuit current $I_p$ (r.m.s.) and corresponding max. allowed cut-off current $i_c$ . The cut-off current $i_c$ refers to values listed by fuse manufacturers	$I_p$ (r.m.s.)	50 kA	kA	16.5	16.5	16.5		
	Max. fuse size gG/aM	415 V	A	125/125	125/125	125/125		
	$I_p$ (r.m.s.)	10 kA	kA	8.2	8.2	8.2		
	Max. fuse size gG/aM	690 V	A	125/100	125/100	125/100		
{ single phase test acc. to IEC60269}	$I_p$ (r.m.s.)	50 kA	kA	10	10	10	35	
	Max. fuse size gG/aM	690 V	A	63/63	63/63	63/63	355/315	
	at prospective SC-current	80 kA	kA				40.5	
	Max. fuse size gG/aM	690 V	A				355/315	
Rated short-time withstand current	r.m.s. -value $I_{cw}$	690 V, 1 s	kA	2.5	2.5	2.5	8	
Rated short circuit making capacity	Peak value $I_{cm}$	690 V/500 V	A	3.6	3.6	3.6	30	
Power loss / pole	At rated operational current		W	0.7	1.6	4.0	6.5	
Mechanical endurance	Divide by two for operation cycles		Oper.	20 000	20 000	20 000	20 000	
Weight without accessories		3-pole	kg	0.36	0.36	0.36	1.2	
		4-pole	kg	0.50	0.50	0.50	1.5	
1) UL Listed switches are also CSA Approved. 2) Fuse size 70A for RK5.								

TECHNICAL DATA ACCORDING TO UL/cULus							
Part Number				M400U	M600U	M800U	M1200U
General Purpose Amp Rating	pf= 0.7...0.8	-5° to 40 °C	A	400	600	800	1200
Maximum Operating Voltage			V	600	600	600	600
Max. horsepower rating / motor FLA current	pf= 0.4...0.5 Three phase	240 V	HP/A	125/312.0	200/480.0	200/602	200/602
		480 V	HP/A	250/302.0	450/515.0	500/590	500/590
		600 V	HP/A	350/338.0	500/472.0	500/472	500/472
	Single phase	120 V	HP/A				
240 V		HP/A					
Short circuit rating with fuse	Maximum fuse size		A	600	600	800	800
	Fuse type	CC	kA				
	Fuse type	J	kA	100		100	
	Fuse type	T	kA			100	
	Fuse type	RK1	kA				
	Fuse type	RK5	kA			100	
	Fuse type	L	kA			100	100
Fuse type	H	kA					
Maximum General Use, DC Ratings							
Current rating		at 250 VDC	A	400	600		
		at 600 VDC	A	200	200		
DC horsepower rating for 4-pole switch		at 600 VDC	HP	50	-		
DC horsepower rating for 2-pole switch	In open air	at 125 VDC	HP	40	-		
	In enclosure <sup>2)</sup>	at 250 VDC	HP	50	50		
DC short circuit rating for 4-pole switch	with circuit breaker		kA	10	10		
DC short circuit rating for 2-pole switch	with circuit breaker at 250 VDC		kA	14	18		
	with circuit breaker at 600 VDC		kA	10	10		
	with class J fuse at 250 VDC		kA	100	100		
	... with fuse size		A	400	500		
Endurances							
Min. electrical endurance, pf. 0.75...0.8			oper. cycles	1 000	1 000	500	500
Mechanical endurance			operations	16 000	10 000	6000	6000
Terminal lug kits				LUG400	LUG800	LUG800	LUG1200
Wire range			AWG	2 - 600MCM	2 x 2 - 600MCM	2 x 2 - 600MCM	4 x 2 - 600MCM
Torque	Wire tightening	lb. in		375	55	500	500
	Lug mounting			240	480	480	450-670
TECHNICAL DATA ACCORDING TO IEC 60947-3							
Rated insulation voltage and rated operational voltage AC20/DC20		Pollution degree 3	V	1 000	1 000	1 000	1 000
Dielectric strength		50 Hz 1min.	kV	10	10	10	10
Rated impulse withstand voltage			kV	12	12	12	12
Rated operational current, AC-22A		up to 415 V	A	400	800	1600	1600
		440...500 V	A	400	800	1600	1600
		690 V	A	400	800	1600	1600
Rated operational current, AC-23A		up to 415 V	A	400	800	1250	1250
		440 V	A	400	800	1250	1250
		500 V	A	400	800	1250	1250
		690 V	A	400	800	1250	1250
Rated conditional short-circuit current $I_p$ [r.m.s.] and corresponding max. allowed cut-off current $\hat{i}_c$ . The cut-off current $\hat{i}_c$ refers to values listed by fuse manufacturers	$I_p$ [r.m.s.]	50 kA	kA				
	Max. fuse size gG/aM	415 V	A				
	$I_p$ [r.m.s.]	50 kA	kA				
	Max. fuse size gG/aM	690 V	A				
(single phase test acc. to IEC60269)	$I_p$ [r.m.s.]	50 kA	kA	50.5	71.5		
	Max. fuse size gG/aM	690 V	A	500/500	800/1 000		
	at prospective SC-current	80 kA	kA	59	83.5		
	Max. fuse size gG/aM	690 V	A	500/500	800/1 000		
Rated short-time withstand current	r.m.s. -value $I_{rw}$	690 V, 1 s	kA	15	20	50	50
Rated short circuit making capacity	Peak value $I_{cm}$	690 V/500 V	A	65	80	110	110
Power loss / pole	At rated operational current		W	10	40	29	48
Mechanical endurance	Divide by two for operation cycles		Oper.	26 000	10 000		
Weight without accessories		3-pole	kg	2.2	5.2	15.2	15.2
		4-pole	kg	2.8	6.4		

1) UL Listed switches are also CSA Approved. 2) Fuse size 70A for RK5.

© 2024 Mersen. All rights reserved. Mersen reserves the right to change, update, or correct, without notice, any information contained in this datasheet.

# UL 98 Fusible

## Disconnect Switches

### LOW VOLTAGE SWITCHES



Mersen’s fusible disconnect switches are listed to UL 98 and bear the CE mark conforming to IEC 60947-3. They are “service entrance” devices capable of fully rated load-break and load-make. While long-term safety, reliability, and functionality are always paramount in the design of our products, these switches are also engineered to have the smallest footprint. The modular design allows placement of the handle anywhere amongst the poles. The fuse doors cannot open when the switch is in the “ON” position, and all switches are double-break, which isolates both fuse clips from voltage during fuse replacement. The switches’ “Test” position allows actuation of the auxiliary contacts without main power. Power taps enable energizing a CPT or surge device without the need for a separate terminal block. A wide range of ergonomic handles and accessories is available.

### CONFIGURATIONS:

\*Not all configurations are available

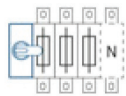

Gearbox on the side

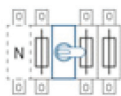

Gearbox in the middle

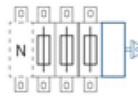

Side operated

### Catalog number designation

<b>M</b> Switch	<b>60</b> Ampacity	<b>J</b> Type	<b>3</b> Number of Poles/Left of handle	<b>0</b> Number of Poles/Right of handle	— Revision	<b>S</b> Special Configuration
M = Mersen AC Switch	30-1200	CC = CC fused J = J fused L = L fused	1, 2, 3, 4, etc. (N = Neutral)	Blank = < 200A non-fused, 0, 2	Blank = 0	S = side-operated N = Non-fused switched Neutral

### RATINGS UL:

- **Volts:** 600VAC
- **Amps:** 30, 60, 100, 200, 400, 600, 800, and 1200A
- **Short-Circuit Current Rating (SCCR):** Up to 200kA with Class CC, J, or L Fuses

### FEATURES/BENEFITS:

- Multiple Configurations
- Power taps
- Adjustable shaft depth
- Fuse monitoring
- Double break, isolating live and load side of fuse
- Interlocked fuse doors

### APPROVALS:

- All UL Fusible Disconnect Switches meet UL & CSA requirements
- UL listed guide WHTY, File E191605 for UL 98 (ratings from 30A to 1200A)
- IEC 60947-3



### UL LISTED FRONT AND SIDE OPERATED



**M30CC12**  
30A, CC fused, 3-pole with pole on left side of handle and 2 poles on right side



**M60J30**  
60A, J fused, with 3 poles on left side of handle



**M200J30 with HDF200**  
200A, J fused, 3 poles on left side of direct handle

Switch Body	Ampere Rating	30	60	100	200
Base Part #		M30	M60	M100	M200
Fuse Type		CC, J	J	J	J
3- and 4-pole configurations		12, 22, 30S	12, 22, 22N, 30, 30S, 40, 40N	12, 22, 22N, 30, 30S, 40, 40N	30, 40
S = Side operated (Direct Side Operated Handles are included with 'S' option)					
Handles and Shafts	Direct Front Operation	HDF30	HDF200	HDF200	HDF200
<b>External Front Operation - Pistol style</b>					
Minimum recommended handle length		45 mm			
NEMA Type 1, 3R, 12, IP65		HB45	HB65, HB80		
NEMA Type 4, 4X		HB45X	HB65X, HB80X		
NEMA 4X Stainless Steel		HM65X			
B=Black. Substitute 'R' for 'B' if a red handle is desired. Ex. HR45					
Shafts					
Shaft— SPAxxx (xxx = length in mm)		SPA130, SPA210, SPA290, SPA360, SPA430			
Accessories	Terminal Lugs	Integral	Integral	LUG100 (#14 - 2/0)	LUG200 (#6 - 300MCM)
<b>Terminal Shrouds</b>					
3-pole (3 single shrouds per package)		Integral	Integral	TSF160-13	TSF200-13
4-pole (4 single shrouds per package)				TSF160-14	TSF200-14
Shrouds with "-3" suffix are single shrouds that cover all three terminals. Shrouds with "-13" or "-14" are single pole shrouds with 3 or 4 per					
Auxiliary Contacts*					
NO		OA1G10, w/OSZ4	OA1G10	OA1G10	OA1G10
NC		OA3G01, w/OSZ4	OA3G01	OA3G01	OA3G01
NO, between poles		OA4B1C	N/A	N/A	N/A
Mounting plate OA1G10/OA3G01		OSZ4	Not needed	Not needed	Not needed
Module for 8 aux. contacts		OEA28	OEA28	OEA28	OEA28
*Rated 2A max continuous @690VAC					
Flange Operation for Cable Actuation					
Cable Flange Handle, NEMA 12		FHC12	FHC12	FHC12	FHC12
Cable Flange Handle, NEMA 4X		FHC4X	FHC4X	FHC4X	FHC4X
Bracket Assembly		FOM2	FOM3 for M60J12, FOM4 for M60J30	FOM4	FOM4
Cable for FHC handles		CABLE36*	CABLE36*	CABLE36*	CABLE36*
*Other cable lengths available: 48", 60", 72", 84", 96", 108". For example, CABLE108.					

© 2024 Mersen. All rights reserved. Mersen reserves the right to change, update, or correct, without notice, any information contained in this datasheet.

### UL LISTED FRONT AND SIDE OPERATED



M400J30  
400A, J fused, 3-pole with 3 poles on left side of handle



M800L30  
800A, L fused, with 3 poles on left side of handle

Switch Body	Ampere Rating	400	600	800	1200
Base Part #		M400	M600	M800	M1200
Fuse Type		J	J	L	L
3- and 4-pole configurations		12, 30, 40	12, 30, 40	12, 30, 40	30, 40
Handles and Shafts	Direct Front Operation				
		HDF400	HDF800T	HDF800T	HDF1250T
	External Front Operation				
	Minimum recommended handle length	95 mm	125 mm	125 mm	274 mm
	NEMA Type 1, 3R, 12	HB125, HB145, HB274			
	NEMA Type 4, 4X	HB125X, HB145X, HB274X			
	NEMA 4X Stainless Steel	HM125X, HM175X			
	B=Black. Substitute 'R' for 'B' if a red handle is desired. Ex. HR125				
	Shafts				
	Shaft—SFBxxx (xxx = length in mm)	SFB185, SFB280, SFB325, SFB395, SFB535			
Accessories	Terminal Lugs				
	6 per package	LUG400 #2 - 600MCM	LUG800 2 x #2 600MCM	LUG800 2 x #2 600MCM	LUG1200 4 x #2 600MCM
	Terminal Shrouds				
	3-pole	TSF400-3	TSF600-3	TSF800-13	TSF1250-13
	Suffix "-3" indicates a single piece 3-pole shroud; Suffix "-13" indicates three individual single pole shrouds per package.				
	When a switch is to be installed with lugs and terminal shrouds, a TSFXXX-3 (single piece, 3-pole) model of shroud is recommended.				
	Auxiliary Contacts*				
	Normally Open	OA1G10	OA1G10	OA1G10	OA1G10
	Normally Closed	OA3G01	OA3G01	OA3G01	OA3G01
	Module for 8 aux. contacts	OEA28	OEA28	OEA28	OEA28
	*Rated 2A max continuous @690VAC				

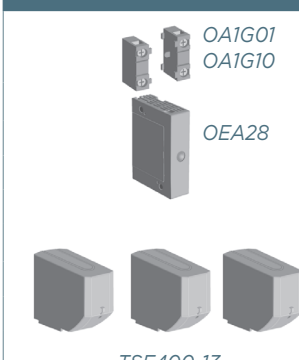
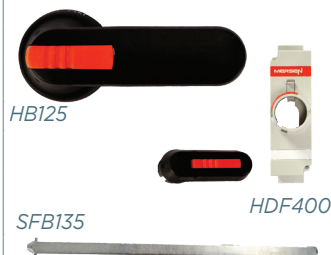

### TEMPERATURE DERATING

Amb. °C (Min)	Amb. °C (Max)	Thermal current (I <sub>th</sub> ) derating
35	40	1.00
40	45	0.96
45	50	0.93
50	55	0.89
55	60	0.85

Amb. °C (Min)	Amb. °C (Max)	Thermal current (I <sub>th</sub> ) derating
60	65	0.80
65	70	0.76
70	75	0.71
75	80	0.65
80	85	0.60

© 2024 Mersen. All rights reserved. Mersen reserves the right to change, update, or correct, without notice, any information contained in this datasheet.

TECHNICAL DATA ACCORDING TO UL/cULus							
General Purpose Amp Rating	pf= 0.7...0.8	-5° to 40 °C	A	30	60	100	200
Maximum Operating Voltage			VAC	600	600	600	600
			VDC	250	250	250	250
Max. horsepower rating / motor FLA current	pf= 0.4...0.5 Three phase	240 V	HP/A	7.5/22.0	15/42.0	30/80.0	60/154.0
		480 V	HP/A	15/21.0	30/40.0	60/77.0	125/156.0
		600 V	HP/A	20/22.0	50/52.0	75/77.0	150/144.0
	Single phase	120 V	HP/A	2/24.0			
240 V		HP/A	3/17.0				
Short circuit rating with fuse, 3- and 4- pole types			kA	200	200	200	200
	UL/CSA fuse size		A	30	60	100	200
	UL/CSA fuse type			J/CC	J	J	J
Endurances							
Min. electrical endurance, pf. 0.75...0.8			oper. cycles	6000	6000	6000	6000
Mechanical endurance			operations	20 000	20 000	20 000	16 000
Terminal lug kits				Integral	Integral	LUG100	LUG200
Wire range			AWG	#18-8	#14-4	#14-2/0	#4-300MCM
Torque		Wire tightening	lb. in	17	30/355	120	275
		Lug mounting	lb. in	N/A	N/A	50	72
TECHNICAL DATA ACCORDING TO IEC 60947-3							
Rated insulation voltage	Pollution degree 3		V	1 000	1 000	1 000	1 000
Dielectric strength		50 Hz 1min.	kV	10	10	10	10
Rated impulse withstand voltage			kV	12			12
Rated thermal current in ambient 40 °C /	In open air		A/W	32/3.5	63/7.5	160/12	200/17
max. fuse power dissipation <sup>1)</sup>	In enclosure <sup>2)</sup>		A/W	32/3.5	63/7.5	160/10, 135/12	200/15
...with minimum cable cross section		Cu	mm <sup>2</sup>	6	16	70	95
Rated operational current, AC-23A		up to 500 V	A	32	63	160	200
		690 V	A	32	63	160	200
Rated operational current, AC-23 <sup>3)</sup>	The kW-ratings are accurate for three-phase 1500 R.P.M. standard asynchronous motors.	230 V	kW	7.5	18.5	45	60
		400 V	kW	15	30	75	110
		415 V	kW	15	30	75	110
		500 V	kW	18.5	37	90	132
Rated breaking capacity in category AC-23		up to 500 V	A	256	504	1280	1600
		690 V	A	256	504	1280	1600
Rated short-time withstand current, 1 s	r.m.s. -value	690 V, 1 s	kA	1	2.5	5	8
Power loss / pole	With rated current, without fuse		W	2	4	9	8
Weight without accessories	3-pole switch fuses		kg	0.7	1.3	1.5	2.6
	4-pole switch fuses		kg	0.9	1.6	1.8	
Built-in terminal size		Cu	mm <sup>2</sup>	0.75...10	2.5...25		
Terminal bolt size (included)	Metric thread diameter x length		mm			M6x20	M8x25
Fuse-links bolts tightening torque			Nm			4	4

\*) = Utilization category B

1) Ambient temperature 60°C: derating 20%

2) Mounting on "ceiling": derating 10%. Mounting on wall, horizontal fuses: derating 8%.

3) Some fuses limit these figures further. Starting current characteristics must be considered separately.

4) Approval pending

5) 30 lb.in with cable size #14-10, 35 lb.in with cable size #8-4

TECHNICAL DATA ACCORDING TO UL/cULus							
General Purpose Amp Rating	pf= 0.7...0.8	-5° to 40 °C	A	400	600	800	1200
Maximum Operating Voltage			VAC	600	600	600	600
			VDC	250	250	250	250
Max. horsepower rating / motor FLA current	pf= 0.4...0.5 Three phase	240 V	HP/A	125.0/312.0	200/480.0	250/602.0	250/602.0
		480 V	HP/A	250.0/302.0	400/477.0	500/590.0	500/590.0
		600 V	HP/A	350.0/336.0	500/472.0	500/472.0	500/472.0
	Single phase	120 V	HP/A				
		240 V	HP/A				
Short circuit rating with fuse, 3- and 4- pole types			kA	200	200	200	200
	UL/CSA fuse size		A	400	600	800	1200
	UL/CSA fuse type			J	J	L	L
Endurances							
Min. electrical endurance, pf. 0.75...0.8			oper. cycles	1 000	1 000	500	500
Mechanical endurance			operations	12 000	4 000	3 000	2 000
Terminal lug kits				LUG400	LUG800	LUG800	LUG1200
Wire range			AWG	#2-600MCM	{2}#2-600MCM	{2}#2-600MCM	{4}#2-600MCM
Torque		Wire tightening	lb.in	375	500	500	500
		Lug mounting	lb.in	240	480	480	480
TECHNICAL DATA ACCORDING TO IEC 60947-3							
Rated insulation voltage	Pollution degree 3		V	1 000	1 000	1 000	1 000
Dielectric strength		50 Hz 1min.	kV	10	10	10	10
Rated impulse withstand voltage			kV	12	12	12	12
Rated thermal current in ambient 40 °C /	In open air		A/W	400/45	630/60	800/65	1250/110
max. fuse power dissipation <sup>1)</sup>	In enclosure <sup>2)</sup>		A/W	400/30	570/50	720/55	1000/85
...with minimum cable cross section		Cu	mm <sup>2</sup>	240	2x185	2x240	2x400
Rated operational current, AC-23A		up to 500 V	A	400	630	800	1000 <sup>*)</sup>
		690 V	A	400	630	800	1000 <sup>*)</sup>
Rated operational current, AC-23 <sup>3)</sup>	The kW-ratings are accurate for three-phase 1500 R.P.M. standard asynchronous motors.	230 V	kW	132	200	250	315 <sup>*)</sup>
		400 V	kW	220	355	450	560 <sup>*)</sup>
		415 V	kW	230	355	450	560 <sup>*)</sup>
		500 V	kW	280	450	560	710 <sup>*)</sup>
		690 V	kW	400	630	710	1000 <sup>*)</sup>
Rated breaking capacity in category AC-23		up to 500 V	A	3200	6400	6400	8000
		690 V	A	3200	6400	6400	8000
Rated short-time withstand current, 1 s	r.m.s. -value		kA	14	20	20	
Power loss / pole	With rated current, without fuse		W	30	46	75	75
Weight without accessories	3-pole switch fuses		kg	5.7	11.5	11.5	29
	4-pole switch fuses		kg				
Built-in terminal size		Cu	mm <sup>2</sup>				
Terminal bolt size (included)	Metric thread diameter x length		mm	M10x30	M12x40	M12x40	M12x50
Fuse-links bolts tightening torque			Nm	20	40	40	40

\*) = Utilization category B

1) Ambient temperature 60°C: derating 20%

2) Mounting on "ceiling": derating 10%. Mounting on wall, horizontal fuses: derating 8%.

3) Some fuses limit these figures further. Starting current characteristics must be considered separately.

4) Approval pending

5) 30 lb.in with cable size #14-10, 35 lb.in with cable size #8-4



# PV-Rated Disconnect Switches

## LOW VOLTAGE SWITCHES



Mersen offers a range of DC disconnect switches specially designed for PV applications, in one- and two-circuit configurations for both 1000VDC applications. The technology inside the switch and the visible contacts allow a quick, safe, and reliable DC breaking at all current levels up to 1000VDC. The product is ready and simple to install independent of the polarity, with limited power losses, and a smaller footprint than competition.

### APPLICATIONS:

- Medium and large power photovoltaic installations up to 1000VDC
- “Make and break” on load and provide safety isolation at string combiner box level

### RATINGS:

- **Volts:** 1000VDC
- **Amps:** IEC: 100 to 500A, UL98: 100 to 400A
- **Short-Circuit Current Rating (SCCR):** 5 to 10kA for higher ratings

### FEATURES/BENEFITS:













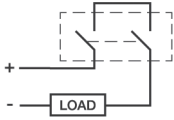
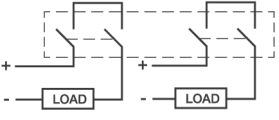
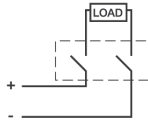
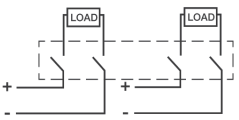

- IEC version and UL version
- Visible contacts
- Compact footprint
- Direct installation for floating polarity configuration
- Jumper bar available for grounded configuration

### APPROVALS:

- UL98B File #E466972 WHVA
- IEC 60947-3 CE

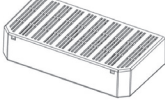

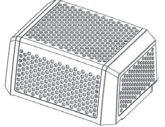
Catalog number designation					
<b>MD</b> Switch	<b>100</b> Ampacity	<b>E</b> Type	<b>1</b> Number of Poles/Left of handle	<b>1</b> Number of Poles/Right of handle	— Revision
 MD = Mersen DC Switch	 100-500A	 E = IEC U = UL-listed V = 1500V	 1, 2, 3	 1, 2, 3	 Blank = 0

UL 98B Listed DC Switches								
								
MD100U11	MD100U22	MD100E11	MD100E22					
								
Switch Body	Ampere Rating	100	100	160	200	200	250	
	1000VDC 2-pole Configuration	MD100U11	MD100E11	MD160E11	MD200U11	MD200E11	MD250E11	
	1000VDC 2x2-pole Configuration	MD180U22	MD100E22	MD160E22	MD180U22*	MD200E22	MD250E22	
	B=Black. Substitute 'R' for 'B' if a red handle is desired. Ex. HR45 *180A Rating							
Handles and Shafts	Direct Front Operation							
	1000VDC	HDD250	HDD250	HDD250	HDD250	HDD250	HDD250	
	External Pistol style							
	NEMA Type 1, 3R, 12	HB65, HB80						
	NEMA Type 4, 4X	HB65X, HB80X						
	B=Black. Substitute 'R' for 'B' if a red handle is desired. Ex. HR65							
	Shafts							
	Shaft — SPAxxx (xxx = length in mm), SFBxxx (xxx = length in mm)	SPA130, SPA210, SPA290, SPA360, SPA430						
Accessories	Auxiliary Contacts*							
	NO Right side mounting	OA1G10	OA1G10	OA1G10	OA1G10	OA1G10	OA1G10	
	NC left side mounting	OA3G01	OA3G01	OA3G01	OA3G01	OA3G01	OA3G01	
	Module for SF aux. contacts	OEA28	OEA28	OEA28	OEA28	OEA28	OEA28	
	*Rated 2A max continuous @690VAC							
	<th>Terminal Shroud for Short Circuit Link</th>	Terminal Shroud for Short Circuit Link						
	For MDxxxU11, UV12	JC250			JC250			
	For MDxxxU22	JC500-2			JC500-2			
	For MDxxxE11, E22, EV12**		JUMP250	JUMP250		JUMP250	JUMP250	
	**Shipped with one link per circuit							
	<th>Terminal Shroud for Lugs</th>	Terminal Shroud for Lugs						
	1 Terminal Shroud	TDS250S			TDS250S			
	Kit of 4 Terminal Shrouds		TS250-14	TS250-14		TS250-14	TS250-14	
	A shorter version is available for DC Switches up to 250A. 1 piece per package: TDS250S							

© 2024 Mersen. All rights reserved. Mersen reserves the right to change, update, or correct, without notice, any information contained in this datasheet.

### TECHNICAL DATA FOR 1000VDC-RATED SWITCHES

Technical data in accordance to UL 98B for switch-disconnectors  
(Suitable for use in photovoltaic systems in accordance with article 690 of the NEC)

Switch Size			MD100U	MD200U	MD250U	MD315U	MD400U
Voltage Rating		VDC	1000	1000	1000	1000	1000
Current Rating		A	100	200 1)	250	320	400
Rated Ambient Temp.		°C	-20...+50	-20...+50	-20...+50	-20...+50	-20...+50
Short Circuit Rating		kA, 1000V	5	5	10	10	10
	Class of Fuse		Circuit breaker	Circuit breaker	Circuit breaker	Circuit breaker	Circuit breaker
Mechanical Endurance (Divide by 2 for operation cycles) Oper.			4000	4000	2000	2000	2000
Terminal Lugs			LUG200	LUG200	LUG400	LUG400	LUG400
Wire Range		MCM	#4-300	#4-300	#2-600	#2-600	#2-600
Technical data according to IEC		Same as type	MD160E	MD250E	MD315E	MD400E	MD500E

1) For 4 pole switches (double circuit use), the current rating at 1000 VDC is 180 A.

### TECHNICAL DATA ACCORDING TO IEC 60947 FOR SWITCH-DISCONNECTORS

Switch Size		A	MD100E	MD160E	MD200E	MD250E
Rated Insulation voltage $U_i$	Pollution degree 2	V	1500	1500	1500	1500
	Pollution degree 3	V	1500	1500	1500	1500
Rated impulse withstand	50 Hz 1 min	kV				
		kV	12	12	12	12
Rated thermal current $I_{th}$ ...with minimum cable or bar cross section	In open air, normal conditions <sup>1)</sup>	A	100	160	200	250
	In enclosure 40°C	A	100	160	200	250
	In enclosure 60°C	A	100	160	200	250
	Cu	mm <sup>2</sup>	35	70	95	120
Rated operational current / poles in series DC-21B	1000	V	100 / 2	160 / 2	200 / 2	250 / 2
			100 / 2x2	160 / 2x2	200 / 2x2	250 / 2x2
Rated short-time withstand current, 1000 V, 1 s, R.M.S. -value $I^{cm}$		kA	5	5	5	5
Rated short circuit making capacity, 1000 V, Peak value $I_{cm}$		kA	5	5	5	5
Power loss / pole	At rated current	W	2	4	6	9,5
Cable size	Cu	mm <sup>2</sup>				
Terminal bolt size	Metric thread diameter x length	mm	M8x25	M8x25	M8x25	M8x25
Terminal tightening torque	Counter torque required	Nm	15-22	15-22	15-22	15-22

1) Normal conditions defined in IEC 60947-1-6.1

# Enclosed Disconnect Switches

## LOW VOLTAGE SWITCHES



Mersen enclosed disconnect switches are designed to meet customers' requirements for compact and durable individual disconnecting means. Both fusible and non-fusible versions are available in a variety of enclosure types resulting in one of the largest available ranges in the industry. The enclosed disconnect switch range offers safety, ease of installation, space savings and operational convenience to end-users.

Mersen features NEMA style, Type 4X non-metallic and stainless steel enclosures that are extremely durable and provide the ultimate protection for harsh environments and conditions. These rugged enclosure types are often used in areas where "wash down" applications are required.

### APPLICATIONS:

- Load break switching
- Separate disconnect means within sight of all motor loads to comply with NEC® Article 430
- Circuit isolation
- Service entrance ratings available
- Food processing
- Conveyor systems
- Harsh industrial environments

### RATINGS:

#### Fusible

- **Volts:** 600VAC
- **Amps:** 30 to 800A

#### Non-Fusible

- **Volts:** 600VAC
- **Amps:** 16 to 1200A
  
- **Volts:** 600VDC
- **Amps:** 100 to 400A

### HIGHLIGHTS:

- Suitable for use as motor disconnect
- Meets OSHA lockout/tagout requirements
- NEMA rated enclosures
- Knockouts provided
- Easy screw mounting
- Selector or pistol handles in black or red/yellow
- Clear ON/OFF indication

### APPROVALS:

- UL 508A
- UL 508
- UL 98
- CSA
- IEC versions available



### PART NUMBERING GUIDELINE (EXAMPLE)

ED	FS	30	3	R	S	0	-
Enclosure Type	Switch Type	Amp Rating	Number of Poles	Color of handle: R = Red/yellow B = Black	Type of handle: S = Selector P = Pistol	Auxiliary contacts: See chart below	Other options

Switch Type		Part Numbers	Auxiliary Contact Suffix				
			0	1	2	3	4
FS	UL 508 Non-Fused	M163 to M803	None	1 NO	1 NC	1 NO + NC	1 NO + NO
FC or SC	UL 98 Non-Fused	M30U to M1200U	None	1 NO	1 NC	1 NO + NC	1 NO + NO
FB	UL 98 Fused	MxxC, J, L	None	1 NO	1 NC	1 NO + NC	1 NO + NO

### OTHER OPTIONS

Please consult factory for availability and suffix for any other options including:

- Neutral blocks (N)
- If terminal shrouds are necessary, add a "T" to the end of the part number.
- Special Request
  - Pilot lights
  - Push buttons
  - 2 or 3 position selector switches

### ALL ENCLOSED SWITCHES ARE PROVIDED WITH A STANDARD INTEGRAL GROUND LUG

Box type	Switch type	Ground lug wire size
NEMA/UL	16 – 60A	#4 – #14
NEMA/UL	80 – 125A	(2) 1/0 – #14
NEMA/UL	200 – 400A	(2) 600kcmil – #2
NEMA/UL	600A & above	Consult Factory

Note: EDFs 40A, 60A & 80A use grounding stud

### ENCLOSURE APPLICATION INFORMATION

Enclosure Type		Intended Use and Description
NEMA	1	Indoor use primarily to provide a degree of protection against contact with the enclosed equipment and against a limited amount of falling dirt.
NEMA	3R	Intended for outdoor use primarily to provide a degree of protection against rain, sleet, and damage from external ice formation.
NEMA	12	Intended for indoor use primarily to provide a degree of protection against circulating dust, falling dirt, and dripping non-corrosive liquids.
NEMA	4	Intended for indoor or outdoor use primarily to provide a degree of protection against windblown dust and rain, splashing water, hose-directed water, and damage from external ice formation.
NEMA	4X	Intended for indoor or outdoor use primarily to provide a degree of protection against corrosion, wind blown dust and rain, splashing water, hose-directed water, and damage from ice formation.
IEC	IP65	Total protection against dust and protected against water jets from any hosed direction.

© 2024 Mersen. All rights reserved. Mersen reserves the right to change, update, or correct, without notice, any information contained in this datasheet.

NEMA ENCLOSURE 3 Pole, 600V 30-1200A, Non-fused			1	3R	12	4	4X Stainless	4X Non-Metallic
Ampere Rating (A)			Catalog Numbers					
UL 508	16	Special compact polycarbonate enclosures						EJM16BS0S
	40	Special compact polycarbonate enclosures						EJM30BS0
	60	Special compact polycarbonate enclosures						EJM60BS0
	16	EAFS163RS0	EFFS163RS0	ECFS163RS0	EHFS163RS0	EBFS163RS0	EDFS163RS0	
	25	EAFS253RS0	EFFS253RS0	ECFS253RS0	EHFS253RS0	EBFS253RS0	EDFS253RS0	
	30	EAFS303RS0	EFFS303RS0	ECFS303RS0	EHFS303RS0	EBFS303RS0	EDFS303RS0	
	40	EAFS403RS0	EFFS403RS0	ECFS403RS0	EHFS403RS0	EBFS403RS0	EDFS403RS0	
	60	EAFS603RPO	EFFS603RPO	ECFS603RPO	EHFS603RPO	EBFS603RPO	EDFS603RPO	
UL 98	80	EAFS803RPO	EFFS803RPO	ECFS803RPO	EHFS803RPO	EBFS803RPO	EGFS803RPO	
	30	E AFC303RPO	EFFC303RPO	ECFC303RPO	EHFC303RPO	EBFC303RPO	EGFC303RPO	
	60	E AFC603RPO	EFFC603RPO	ECFC603RPO	EHFC603RPO	EBFC603RPO	EGFC603RPO	
	100	E AFC1003RPO	EFFC1003RPO	ECFC1003RPO	EHFC1003RPO	EBFC1003RPO	EGFC1003RPO	
	200	E AFC2003RPO	EFFC2003RPO	ECFC2003RPO	EHFC2003RPO	EBFC2003RPO	EGFC2003RPO	
	400	E AFC4003RPO	EFFC4003RPO	ECFC4003RPO	EHFC4003RPO	EBFC4003RPO	EGFC4003RPO	
	600	E ASC6003RPO	EFSC6003RPO	ECSC6003RPO	EHSC6003RPO	EBSC6003RPO	EGSC6003RPO	
	800	E ASC8003RPO	EFSC8003RPO	ECSC8003RPO	EHSC8003RPO	EBSC8003RPO	EGSC8003RPO	
NEMA ENCLOSURE 3 Pole, 600V 30-800A, Fused			1	3R	12	4	4X Stainless	4X Non-Metallic
	Ampere Rating (A)	Fuse Type	Catalog Numbers					
UL 98	30, compact	CC	EAFBCC303RPO	EFBCC303RPO	ECFBCC303RPO	EHFBCC303RPO	EBFCC303RPO	EGFBCC303RPO
	30	J	EAFBX303RPO	EFBX303RPO	ECFBX303RPO	EHFBX303RPO	EBFBX303RPO	EGFBX303RPO
	60	J	EAFBX603RPO	EFBX603RPO	ECFBX603RPO	EHFBX603RPO	EBFBX603RPO	EGFBX603RPO
	100	J	EAFBX1003RPO	EFBX1003RPO	ECFBX1003RPO	EHFBX1003RPO	EBFBX1003RPO	EGFBX1003RPO
	200	J	EAFBX2003RPO	EFBX2003RPO	ECFBX2003RPO	EHFBX2003RPO	EBFBX2003RPO	EGFBX2003RPO
	400	J	EAFBJ4003RPO	EFBJ4003RPO	ECFBJ4003RPO	EHFBJ4003RPO	EBFBJ4003RPO	EGFBJ4003RPO
	600	J	EAFBJ6003RPO	EFBJ6003RPO	ECFBJ6003RPO	EHFBJ6003RPO	EBFBJ6003RPO	EGFBJ6003RPO
	800	L	EAFBL8003RPO	EFBL8003RPO	ECFBL8003RPO	EHFBL8003RPO	EBFBL8003RPO	EGFBL8003RPO

Notes: Each of the above enclosed switches are listed having a red/yellow handle. Simply replace the "RS" or "RP" with a "BS" or "BP" to receive with a black handle. The non-metallic enclosures are comprised of "ED" polycarbonate and "EG" polyester fiberglass.

© 2024 Mersen. All rights reserved. Mersen reserves the right to change, update, or correct, without notice, any information contained in this datasheet.

Switch Rating	Enclosure Type	H height (in)	W width (in)	D depth (in)	MH mounting height (in)	MW mounting width (in)	Shipping Weight (lbs)	Figure No.
16-40A (M163-M403) UL508	1	8	8	6	5	7	10	2
	3R	8	8	6	9	3	11	1
	12	8	6	6	8.75	4	7	1
	4	5.91	5.91	4.72	5.2	3.36	7	2
	4X Stainless	5.91	5.91	4.72	5.2	3.36	7	2
	4X Non-Metallic	7	5	5	6.18	4.21	2	2
60A (M633) UL508	1	8	8	6	5	7	10	2
	3R	8	8	6	9	3	10	1
	12	8	6	6	8.75	4	7	1
	4	7.87	5.91	4.72	7.15	3.36	7	2
	4X Stainless	7.87	5.91	4.72	7.15	3.36	7	2
	4X Non-Metallic	7	5	5	6.18	4.21	4	2
80A (M803) UL508	1	10	10	6	7	9	10.6	2
	3R	10	8	6	11	3	11.1	1
	12	10	8	6	10.75	6	12.3	1
	4	9.84	7.87	5.91	9.13	5.31	9.8	2
	4X Stainless	9.84	7.87	5.91	9.13	5.31	9.8	2
	4X Non-Metallic	11.63	9.32	6.58	10.75	6	6	1

### DIMENSIONS (IN / MM)

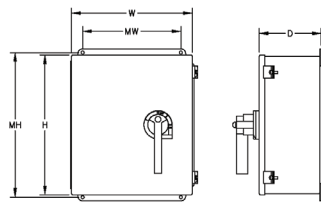

Figure 1

#### EJM16BSOS & EJM30BSx (enclosure size 1)

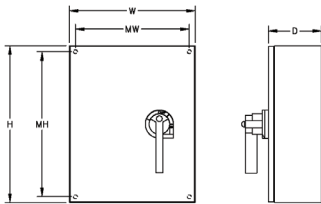
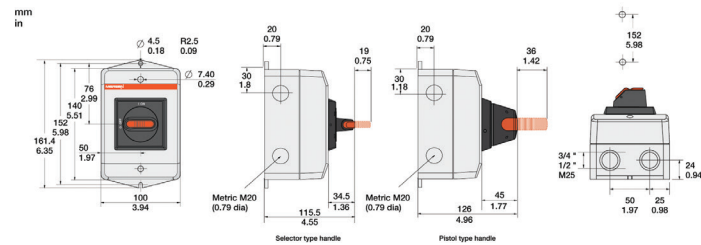
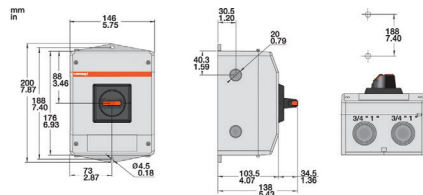
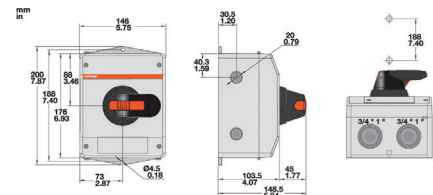

Figure 2

#### EJM60BSx (enclosure size 2)



#### EJM60BPx (enclosure size 2)





Switch Rating	Enclosure Type	H height (in)	W width (in)	D depth (in)	MH mounting height (in)	MW mounting width (in)	Shipping Weight (lbs)	Figure No.
30A [M30U3] UL98	1	10	10	6	7	9	9.3	2
	3R	8	8	6	9	3	10.2	1
	12	8	6	6	8.75	4	7.6	1
	4	9.84	7.87	5.91	9.12	5.33	7.6	2
	4X Stainless	9.84	7.87	5.91	9.12	5.33	10.1	2
	4X Non-Metallic	11.63	9.32	6.58	10.75	6	6.2	1
60A [M60U3] UL98	1	10	10	6	7	9	16	2
	3R	10	8	6	11	3	17.6	1
	12	10	8	6	10.75	6	21.6	1
	4	9.84	7.87	5.91	9.12	5.33	21.9	2
	4X Stainless	9.84	7.87	5.91	9.12	5.33	17.4	2
	4X Non-Metallic	11.63	9.32	6.58	10.75	6	12.9	1
100A [M100U3] UL98	1	12	10	6	9	9	10.6	2
	3R	12	12	6	13	3	11.1	1
	12	12	12	6	12.75	10	12.3	1
	4	11.81	9.84	5.91	11.08	7.3	11.8	2
	4X Stainless	12	10	6	12.75	8	9.8	1
	4X Non-Metallic	13.56	11.5	5.22	12.75	8	7.6	1
200A [M200U3] UL98	1	24	20	8.62	21.88	15	68.6	2
	3R	24	20	8	25	13	88.6	1
	12	24	20	8	25.25	14	70.1	1
	4	24	16	8	22.5	14.5	70.1	2
	4X Stainless	24	20	8	25.25	14	71	1
	4X Non-Metallic	24	16	9	26	15.11	59.3	1
400A [M400U3] UL98	1	42	30	9.25	39.88	22.76	133	2
	3R	42	30	12	43	27	154	1
	12	42	30	8	43.24	24	135	1
	4	42	36	10	40.5	34.5	161	2
	4X Stainless	42	30	10	43.24	24	139	1
	4X Non-metallic	40.75	32.87	11.81	38.66	31.65	67	1
600A [M600U3] UL98	1	42	30	9.25	39.88	22.76	140	2
	3R	42	30	12	43	27	161	1
	12	42	30	12	43.24	24	155	1
	4	42	36	8	43.24	30	163	1
	4X Stainless	42	36	10	40.5	34.5	163	2
	4X Non-metallic	40.75	32.87	11.81	38.66	31.65	74	1
800A [M800U3] UL98	1	42	30	9.25	39.88	22.76	162	2
	3R	48	36	12	29	27	227	1
	12	48	36	12	49.24	30	212	1
	4	48	36	12	49.24	30	221	1
	4X Stainless	48	36	12	46.5	34.5	219	2
	4X Non-metallic	48.25	36.25	12	49.58	30	162	1
1000A [M1200U3] UL98	1	48	36	13.25	45.88	28.76	222	2
	3R	48	36	12	29	27	227	1
	12	48	36	12	49.24	30	212	1
	4	48	36	12	49.24	30	221	1
	4X Stainless	48	36	12	46.5	34.5	219	2
	4X Non-metallic	48.25	36.25	12	49.58	30	162	1
1200A [M1200U3] UL98	1	48	36	13.25	45.88	28.76	222	2
	3R	48	36	12	29	27	227	1
	12	48	36	12	49.24	30	212	1
	4	48	36	12	49.24	30	221	1
	4X Stainless	48	36	12	46.5	34.5	219	2
	4X Non-metallic	48.25	36.25	12	49.58	30	162	1

Note: Dimensions are subject to change! Please consult factory for verification.

© 2024 Mersen. All rights reserved. Mersen reserves the right to change, update, or correct, without notice, any information contained in this datasheet.

Switch Rating	Enclosure Type	H height (in)	W width (in)	D depth (in)	MH mounting height (in)	MW mounting width (in)	Shipping Weight (lbs)	Figure No.
30A {M30CC12} UL 98	1	12	12	6	9	11	9.4	2
	3R	12	12	10	13	3	10.3	1
	12	12	10	8	12.75	8	10.8	1
	4	9.84	7.87	5.91	9.12	5.33	10.8	2
	4X Stainless	9.84	9.32	6.58	10.75	6	11.3	2
	4X Non-Metallic	11.63	9.31	6.93	10.75	6	9.7	1
30A {M30J12} UL 98	1	12	12	6	9	11	18.3	2
	3R	12	12	10	13	3	23.2	1
	12	12	10	8	12.75	8	14.4	1
	4	9.84	7.87	5.91	9.12	5.33	22.4	2
	4X Stainless	9.84	7.87	5.91	9.12	5.33	24.3	2
	4X Non-Metallic	11.63	9.3	6.93	10.75	6	9.7	1
60A {M60J30} UL 98	1	12	12	8	9	11	18.2	2
	3R	12	12	10	13	3	23.1	1
	12	12	10	8	12.75	8	14.6	1
	4	9.84	7.87	7.87	13.05	9.27	24.2	2
	4X Stainless	9.84	7.87	7.87	13.05	9.27	24.2	2
	4X Non-Metallic	13.56	11.4	6.57	12.75	8	17.5	1
100A {M100J30} UL 98	1	20	16	8.62	17.88	11	35.2	2
	3R	18	18	10	19	13	41.3	1
	12	20	16	8	21.25	10	35.2	1
	4	20	16	8	18.5	14.5	39	2
	4X Stainless	20	16	8	18.5	14.5	38.1	2
	4X Non-Metallic	19.6	17.6	8.8	18.87	12	25.6	1
200A {M200J30} UL 98	1	24	20	10.62	21.88	15	56.6	2
	3R	24	24	10	25	13	61.2	1
	12	24	16	8	25.25	10	51	1
	4	24	20	8	22.5	18.5	49.5	2
	4X Stainless	24	20	8	22.5	18.5	50.5	2
	4X Non-Metallic	29	20.85	10.63	30.75	19.6	46.3	1
400A {M400J30} UL 98	1	42	30	13.25	39.88	22.76	155	2
	3R	42	30	12	43	27	162	1
	12	42	30	12	43.24	24	156	1
	4	42	36	12	40.5	34.5	176	2
	4X Stainless	42	30	10	43.24	24	147	1
	4X Non-metallic	40.75	32.87	11.81	38.66	31.65	75	1
600A {M600J30} UL 98	1	42	30	13.25	39.88	22.76	172	2
	3R	42	30	12	43	27	179	1
	12	42	30	12	43.24	24	173	1
	4	42	36	12	40.5	34.5	193	2
	4X Stainless	42	30	10	43.24	24	164	1
	4X Non-metallic	40.75	32.87	11.81	38.66	31.65	92	1
800A {M800L30} UL 98	1	48	36	13.25	45.88	28.76	218	2
	3R	48	36	12	29	27	223	1
	12	48	36	12	49.24	30	208	1
	4	48	36	12	49.24	30	217	1
	4X Stainless	48	36	12	46.5	34.5	215	2
	4X Non-metallic	48.25	36.25	12	49.58	30	158	1

Note: Dimensions are subject to change! Please consult factory for verification.

© 2024 Mersen. All rights reserved. Mersen reserves the right to change, update, or correct, without notice, any information contained in this datasheet.

# Compact Fused Switch Class CC

Compact EP

## LOW VOLTAGE SWITCHES

THE NEXT LEVEL OF SAFETY AND  
EASE OF INSTALLATION



Mersen's Compact Fused Disconnect incorporates the switch functionality with the high protection level of a fuse. The switch accepts UL class CC fuses up to 30A. In addition to this, the Compact Fused Disconnect is UL 98 listed and suitable for use as main/feeder device and, in conjunction with CC fuses, is rated for branch circuit protection. It has a smaller footprint compared to a traditional Class CC disconnect with a max interrupting rating of 200kA.

The compact form factor and ease of installation makes it a great choice for panel builders. The easy lockout/tagout feature and IP20 rating ensures additional safety along with the built in switch capability.

Catalog Numbering System: CEP-FS30CC1				
<b>CEP</b>	<b>FS</b>	<b>30</b>	<b>CC</b>	<b>1</b>
Compact Electrical Power	Fused Switch	30 Amps	CC - Accepts Class CC fuses	Single Pole

### RATINGS:

- **Volts:** 347VAC - single pole  
125VDC - single pole  
600VAC - 2-3 pole
- **Amps:** 30A
- **SCCR:** 200kA

### FEATURES/BENEFITS:

- UL 98 30A Fused disconnect
- Smaller footprint compared to a traditional Class CC disconnect
- Accepts Class CC 30A fuses for branch circuit protection
- 35mm DIN rail mounted
- Built-in lockout/tagout feature
- 200kA SCCR rating
- 75°C CU Wire

### APPROVALS:

- cULus Listed file No. E191605
- UL 98 - Open type switches
- CSA C22.2 No. 4 - enclosed and deadfront switches
- IEC 60529 degree of protection IP20



## DIMENSIONS

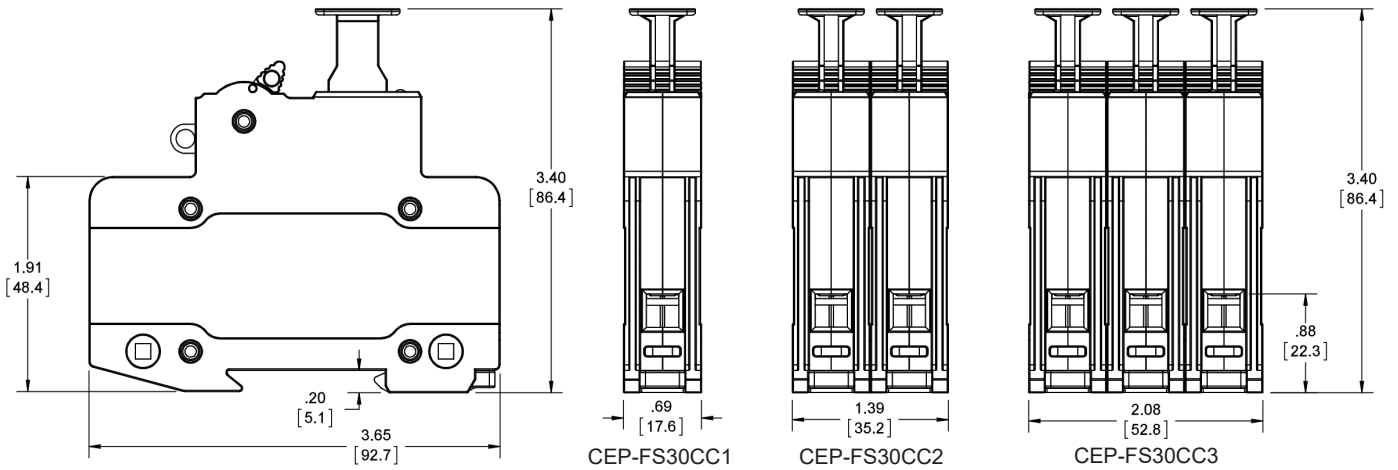

## TERMINAL SPECIFICATIONS

- Wire range #4-18 AWG
- Solid copper wire range 10-18 AWG
- Wire strip length ½"
- Terminal screw driver: Pozidriv style Philips – slot

- Dual wire rated for same-size wire. See table below.

## FACTORY & FIELD WIRING

- Minimum Indicator Voltage - 90VAC

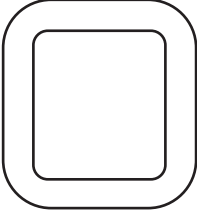
Line Side/Load Side	Wire Size [CU Stranded]	Torque	Wires/Terminal	Wire Class [UL]
	#4 AWG	18 lbf. in 2 N.m	1	B, C
	#6-18 AWG	18 lbf. in 2 N.m	1-2	

## HORSE POWER RATINGS - FOR MOTOR DISCONNECT APPLICATIONS

- CEP-FS30CC1 - 120VAC; 1 Phase; 0.5
- CEP-FS30CC2 - 240VAC; 1 Phase; 1.5
- CEP-FS30CC3 - 240VAC, 3 Phase; 3  
480VAC; 3 Phase; 5  
600VAC; 3 Phase; 7.5
- For motor HP ratings at full load current refer to UL table 50.1 in UL508A
- Max HP requires use of time delay fuses

## ACCESSORIES

- CEP-FS30CC-FC - Replacement Fuse Carrier sold separately